

# DRM212 • DRM215 • DRM315

Professional Powered Loudspeaker Series

**OWNER'S MANUAL**

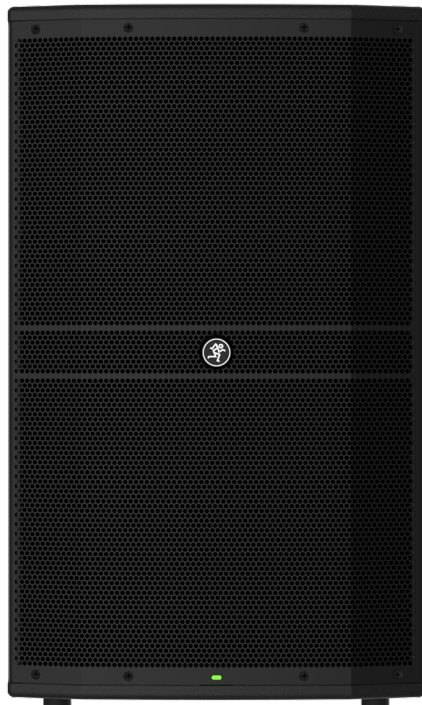

## Important Safety Instructions

1. Read these instructions.
2. Keep these instructions.
3. Heed all warnings.
4. Follow all instructions.
5. Do not use this apparatus near water.
6. Clean only with a dry cloth.
7. Do not block any ventilation openings. Install in accordance with the manufacturer's instructions.
8. Minimum distance (5 cm) around the apparatus for sufficient ventilation. The ventilation should not be impeded by covering the ventilation openings with items, such as newspapers, table-cloths, curtains, etc.
9. Do not install near any heat sources such as radiators, heat registers, stoves, or other apparatus (including amplifiers) that produce heat.
10. No naked flame sources, such as lighted candles, should be placed on the apparatus.
11. Do not defeat the safety purpose of the polarized or grounding-type plug. A polarized plug has two blades with one wider than the other. A grounding-type plug has two blades and a third grounding prong. The wide blade or the third prong are provided for your safety. If the provided plug does not fit into your outlet, consult an electrician for replacement of the obsolete outlet.
12. Protect the power cord from being walked on or pinched particularly at plugs, convenience receptacles, and the point where they exit from the apparatus.
13. Only use attachments/accessories specified by the manufacturer.
14. Use only with a cart, stand, tripod, bracket, or table specified by the manufacturer, or sold with the apparatus. When a cart is used, use caution when moving the cart/apparatus combination to avoid injury from tip-over.
15. Unplug this apparatus during lightning storms or when unused for long periods of time.
16. Refer all servicing to qualified service personnel. Servicing is required when the apparatus has been damaged in any way, such as power-supply cord or plug is damaged, liquid has been spilled or objects have fallen into the apparatus, the apparatus has been exposed to rain or moisture, does not operate normally, or has been dropped.
17. This apparatus shall not be exposed to dripping or splashing, and no object filled with liquids, such as vases or beer glasses, shall be placed on the apparatus.
18. Do not overload wall outlets and extension cords as this can result in a risk of fire or electric shock.



**CAUTION**

RISK OF ELECTRIC SHOCK! DO NOT OPEN!

CAUTION: TO REDUCE THE RISK OF ELECTRIC SHOCK DO NOT REMOVE COVER (OR BACK). NO USER-SERVICEABLE PARTS INSIDE. REFER SERVICING TO QUALIFIED PERSONNEL.

The lightning flash with arrowhead symbol within an equilateral triangle is intended to alert the user to the presence of uninsulated "dangerous voltage" within the product's enclosure, that may be of significant magnitude to constitute a risk of electric shock to persons.

The exclamation point within an equilateral triangle is intended to alert the user of the presence of important operating and maintaining (servicing) instructions in the literature accompanying the appliance.

**WARNING** — To reduce the risk of fire or electric shock, do not expose this apparatus to rain or moisture.

**CAUTION** — To prevent electric shock hazard, do not connect to mains power supply while grille is removed.

19. This apparatus has been designed with Class-I construction and must be connected to a mains socket outlet with a protective earthing connection (the third grounding prong).
20. This apparatus has been equipped with a rocker-style AC mains power switch. This switch is located on the rear panel and should remain readily accessible to the user.
21. The MAINS plug or an appliance coupler is used as the disconnect device, so the disconnect device shall remain readily operable.
22. The use of apparatus is in tropical and/or moderate climates.
23. **NOTE:** This equipment has been tested and found to comply with the limits for a Class A digital device, pursuant to part 15 of the FCC Rules. These limits are designed to provide reasonable protection against harmful interference when the equipment is operated in a commercial environment. This equipment generates, uses, and can radiate radio frequency energy and, if not installed and used in accordance with the instruction manual, may cause harmful interference to radio communications. Operation of this equipment in a residential area is likely to cause harmful interference in which case the user will be required to correct the interference at his own expense.  
**CAUTION:** Changes or modifications to this device not expressly approved by LOUD Audio, LLC could void the user's authority to operate the equipment under FCC rules.
24. This apparatus does not exceed the Class A/Class B (whichever is applicable) limits for radio noise emissions from digital apparatus as set out in the radio interference regulations of the Canadian Department of Communications.  
**ATTENTION** — *Le présent appareil numérique n'émet pas de bruits radioélectriques dépassant les limites applicables aux appareils numériques de class A/de class B (selon le cas) prescrites dans le règlement sur le brouillage radioélectrique édicté par les ministere des communications du Canada.*
25. Exposure to extremely high noise levels may cause permanent hearing loss. Individuals vary considerably in susceptibility to noise-induced hearing loss, but nearly everyone will lose some hearing if exposed to sufficiently intense noise for a period of time. The U.S. Government's Occupational Safety and Health Administration (OSHA) has specified the permissible noise level exposures shown in the following chart.  
According to OSHA, any exposure in excess of these permissible limits could result in some hearing loss. To ensure against potentially dangerous exposure to high sound pressure levels, it is recommended that all persons exposed to equipment capable of producing high sound pressure levels use hearing protectors while the equipment is in operation. Ear plugs or protectors in the ear canals or over the ears must be worn when operating the equipment in order to prevent permanent hearing loss if exposure is in excess of the limits set forth here:

Duration, per day in hours	Sound Level dBA, Slow Response	Typical Example
8	90	Duo in small club
6	92	
4	95	Subway Train
3	97	
2	100	Very loud classical music
1.5	102	
1	105	Matt screaming at Troy about deadlines
0.5	110	
0.25 or less	115	Loudest parts at a rock concert

Laitte on liitettävä suojakoskettimilla varustettuun pistorasiaan.

Apparatet stikprop skal tilsluttes en stikkontakt med jord, som giver forbindelse til stikproppens jord.

Apparatet må tilkoples jordet stikkontakt.

Apparaten skall anslutas till jordat uttag.

**Correct disposal of this product:** This symbol indicates that this product should not be disposed of with your household waste, according to the WEEE directive (2012/19/EU) and your national law. This product should be handed over to an authorized collection site for recycling waste electrical and electronic equipment (EEE). Improper handling of this type of waste could have a possible negative impact on the environment and human health due to potentially hazardous substances that are generally associated with EEE. At the same time, your cooperation in the correct disposal of this product will contribute to the effective usage of natural resources. For more information about where you can drop off your waste equipment for recycling, please contact your local city office, waste authority, or your household waste disposal service.

# Contents

- Important Safety Instructions ..... 2
- Contents / Features ..... 3
- Introduction / Getting Started ..... 4
- Hookup Diagrams ..... 5
  
- DRM Loudspeakers: Rear Panel Features .....10**
  - 1. Power Connection .....10
  - 2. Power Switch .....10
  - 3. XLR and 1/4" Combo Inputs .....10
  - 4. Gain [Ch. 1 and 2] ..... 11
  - 5. Direct Out [Ch. 1 and 2] ..... 11
  - 6. 1/8" Input [Ch. 3/4] ..... 11
  - 7. Gain [Ch. 3/4] ..... 11
  - 8. Mix Out ..... 11
  - 9. LCD Display ..... 11
  - 10. Speaker Control Knob ..... 11
  
- DRM Control Dashboard™ .....12**
  - Main .....12
  - Speaker Mode .....12
  - Sub .....13
  - EQ Setup .....14
  - Delay .....15
  - Configuration .....16
  
- Protection Circuitry .....18**
  - Limiting .....18
  - Overexcursion Protection .....18
  - Thermal Protection .....18
- AC Power .....19**
- Care and Maintenance .....19**
  
- Placement .....19**
- Room Acoustics .....20**
- Rigging .....21**
  
- Appendix A: Service Information ..... 22**
- Appendix B: Technical Information ..... 23**
  - DRM Frequency Graphs ..... 24
  - DRM Dimensions ..... 25
  - DRM Block Diagram ..... 26
  
- Limited Warranty ..... 27**

# Features

- High-efficiency Class-D amplifiers
  - o Up to 2300W of power offers ample headroom for professional applications
  - o Universal power supply (100-240 VAC) with Power Factor Correction technology ensures consistent performance even with unstable AC power
  - o Next-gen protection circuitry keeps transducers safe and ensures peak performance in all applications
  
- Advanced Impulse™ DSP module
  - o Precision crossovers and transducer time-alignment deliver reference quality sound that is consistent throughout the frequency range
  - o Cutting-edge FIR Filtering drastically reduces inherent anomalies, phase issues, and muddy midrange resulting in crystal clear sound
  
- DRM Control Dashboard™ features a high-contrast full color display for easy single-knob access to configuration, processing, and more
  - o View current EQ and voicing mode, high-resolution metering, and more from a single overview window
  - o Application and venue specific modes provide easy to use voicing with minimal setup time
  - o Adjustable 3-band parametric EQ allows for additional customization and tuning for your application and venue
  - o Alignment Delay control for delay stacks
  - o Save and recall up to 6 user presets for various applications and venues
  - o Screensaver plus dimmer and contrast control
  - o System lock with 4-digit passcode
  
- Dual independent inputs that support mic, line, and instrument signals plus a dedicated 1/8" stereo aux input
  
- Premium components and cabinet design
  - o Road-worthy plywood construction and internal bracing offers optimal acoustic performance with a touring-grade textured coating and powder-coated heavy gauge steel grille
  - o Unique ported design provides exceptionally smooth yet punchy low frequency response while providing cool air directly to the internal amplifier
  - o Titanium diaphragm compression drivers are perfectly matched to the amplifier for maximum transparency and clarity
  - o Custom high-excursion woofers offer minimal distortion with increased bass response and reliability to withstand the most demanding live applications
  
- Versatile configuration
  - o DRM212 and DRM215 feature an angled cabinet design for use as floor monitors and dual angle pole-mounts for optimal coverage
  - o DRM315 features a single angle pole-mount
  
- Professional rigging options
  - o M10 flypoints for professional installations\*\*

\*\*DRM212 and DRM215 can be flown in vertical orientation only  
 \*\*DRM315 can be flown in both horizontal and vertical orientation



Like us



Follow us



Watch our dang videos

## Introduction

DRM Series Professional Powered Loudspeakers deliver class-leading power via ultra-efficient Class-D amplifiers with next-gen protection and Power Factor Correction technology for peak performance when you need it.

Advanced Impulse™ DSP provides acoustic correction and time-alignment via precision tuned FIR filters for crystal clear, punchy sound typically experienced only with massive touring systems. The DRM Control Dashboard™ features a high-contrast, full-color display on the back panel for quick and easy setup.

Custom transducers housed in touring-grade plywood cabinets are designed for consistent performance in the most demanding applications.

Equipped with M10 flypoints, dual angle pole mounts, and available line array configurations – the DRM Series is perfect for clubs, houses of worship, rental systems and more.

### How to Use This Manual:

After this introduction, a getting started guide will help you get things set up fast. The hookup diagrams show some typical DRM loudspeaker setups, including some that involve the DRM18S subwoofer.



This icon marks information that is critically important or unique! For your own good, read and remember them...it is a good idea to pay special attention to these areas in the Owner's Manual marked with the "VERY IMPORTANT" hand icon.



There's an illustration of a microscope, so, of course, you're going to get more detailed information when you see this little guy. There are explanations of features and practical tips listed here.



It's a good idea to pay attention to text displayed next to a note icon, as this icon draws attention to certain features and functions relating to the usage of the DRM Series.

**Please write the serial numbers here for future reference (i.e., insurance claims, tech support, return authorization, make dad proud, etc.)**

**Purchased at:**

**Date of purchase:**

## Getting Started

The following steps will help you set up the loudspeakers quickly.

1. Make all initial connections with the power switches OFF on all equipment. Make sure the master volume, level and gain controls are all the way down.
2. If not using a subwoofer, connect the outputs from the mixing console (or other signal source) to the inputs on the rear panel of the loudspeakers.
3. If using a subwoofer, connect the outputs from the mixing console (or other signal source) to the inputs on the subwoofer, then connect the high pass outputs from the subwoofer to the inputs of the loudspeakers.
4. Push the line cord securely into the subwoofer's / loudspeaker's IEC connectors and plug the other ends into grounded AC outlets. The subwoofer/loudspeaker may accept the appropriate voltage as indicated near the IEC connector.
5. Turn the mixer (or other signal source) on.
6. Turn the subwoofer on (if applicable).
7. Turn the loudspeakers on.
8. Make sure the loudspeaker's channel levels are set to (or near) 0 dB.
9. Start the signal source and raise the mixer's main L/R fader up to a comfortably loud listening level.

### Things to Remember:

- Never listen to loud music for prolonged periods. Please see the Safety Instructions on page 2 for information on hearing protection.
- As a general guide, the mixer (or other signal source) should be turned on first, subwoofers next, and DRM loudspeakers last. As such, the DRM loudspeakers should also be turned off first, followed by the subwoofers, then the mixer. This will reduce the possibility of any turn-on or turn-off thumps and other noises generated by any upstream equipment from coming out of the speakers.
- Save the shipping boxes and packing materials! You may need them someday. Besides, the cats will love playing in them and jumping out at you unexpectedly. Remember to pretend like you are surprised!
- Save your sales receipt in a safe place.

## Hookup Diagrams

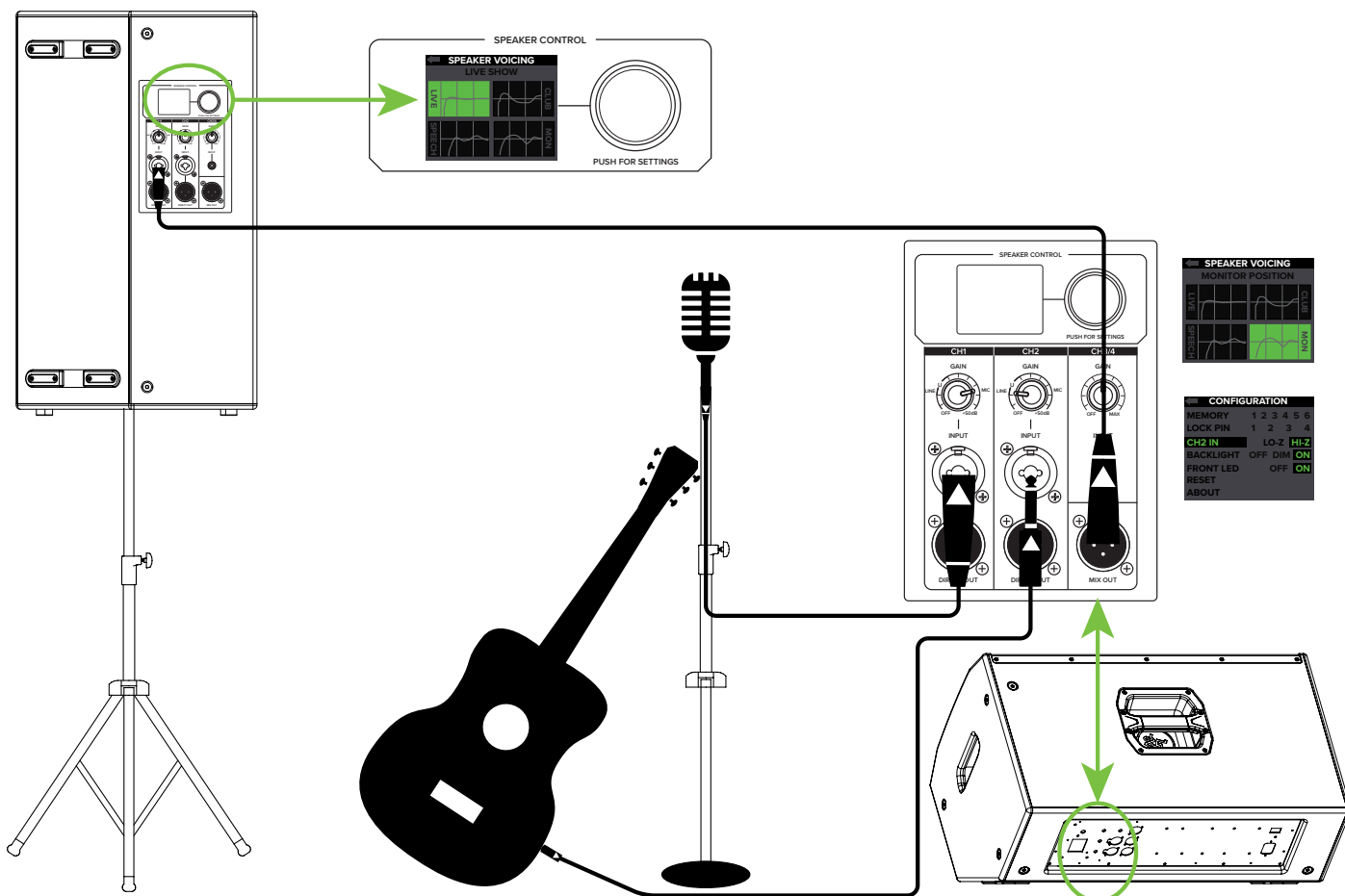

DRM loudspeakers are the perfect tool for singer-songwriters touring the local coffee shops. Bring your favorite axe and mic, DRM loudspeakers and cables and power cords.

In this example, a dynamic microphone is connected to the channel 1 input of a DRM212 loudspeaker, used for monitoring purposes.

Now grab your axe and plug it directly into the channel 2 input. Or if you use effects, connect the guitar to the effects input and another cable from the effects output to the channel 2 input.

A DRM215 loudspeaker will be used for the main PA. Simply connect a cable from the DRM212 monitor's MIX OUT jack to the DRM215 PA's channel 1 input.

For the output, you will want to set a speaker mode, described in detail on page 12. For this type of setup, Live works well for the main DRM215. Select the Monitor mode for the DRM212 monitor. Additionally, you will want to set the monitor's configuration > channel 2 input to Hi-Z to account for the guitar.

### Singer-Songwriter Setup



Hookup Diagrams continued...

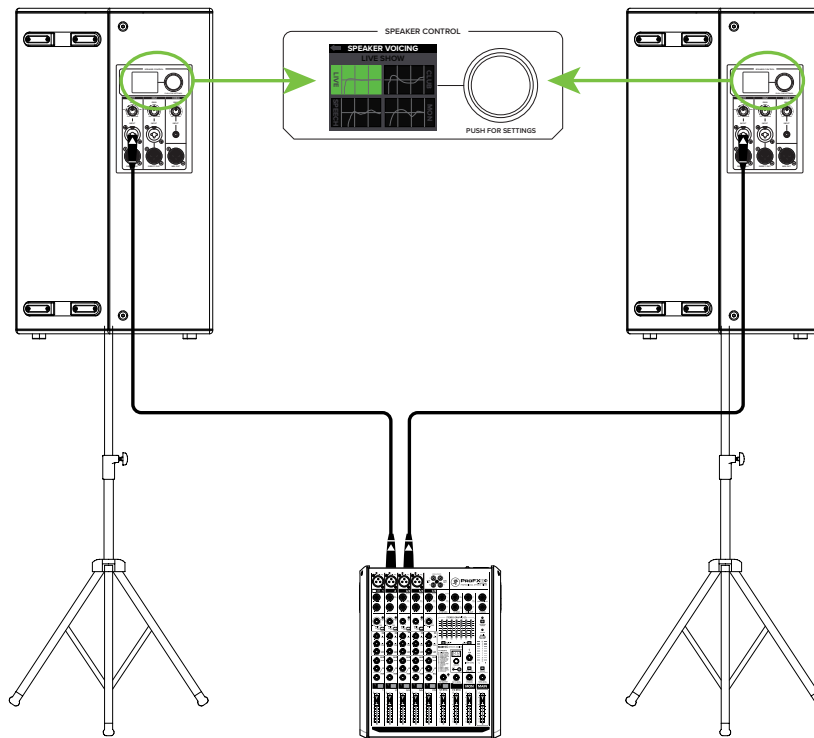

In this example, a ProFX8v2 mixer is connected directly to two DRM215 loudspeakers. It is the perfect setup for a small club or... a fun karaoke house party! Simply connect the L/R outputs of the ProFX8v2 mixer to the CH1 input of each DRM215 loudspeaker. Don't forget to set the Speaker Mode on both loudspeakers to Live... or Club if you want a little more low-end thump!

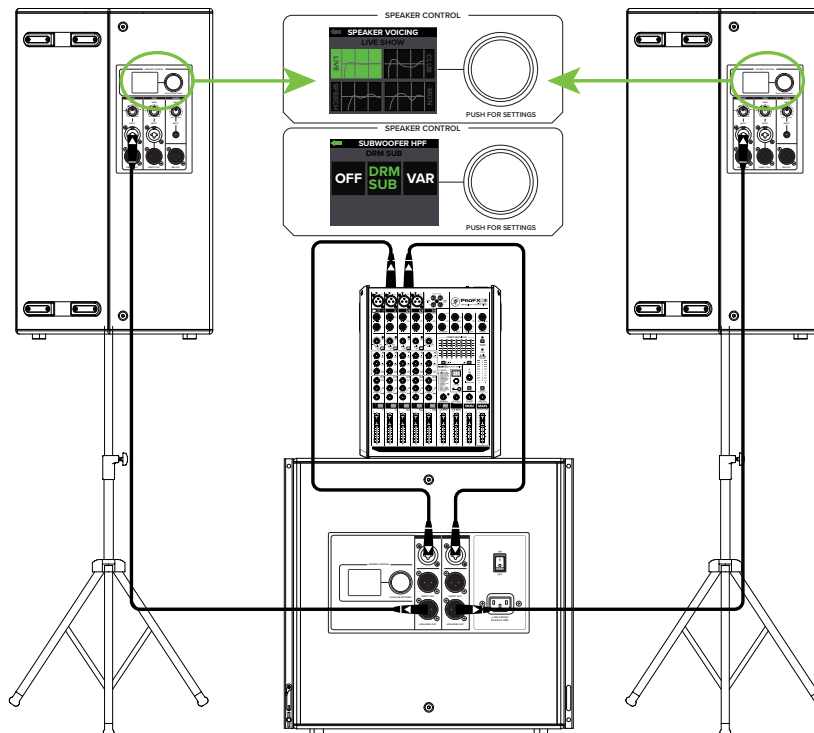

If you desire a little more boom, add a DRM18S subwoofer to the mix. Here, the L/R outputs of a ProFX8v2 mixer are connected directly to the CH1 and CH2 inputs of the DRM18S subwoofer. Then the High-Pass Outs of the subwoofer are connected to the channel 1 inputs of a pair of DRM215 loudspeakers. Here you will want to set the Speaker Mode to either Live or Club and the Subwoofer HPF to DRM Sub (or Var if using a different subwoofer). If using a DRM18S, change its X-Over to DRM Top for a perfectly matched set!

Small Club System

## Hookup Diagrams continued...

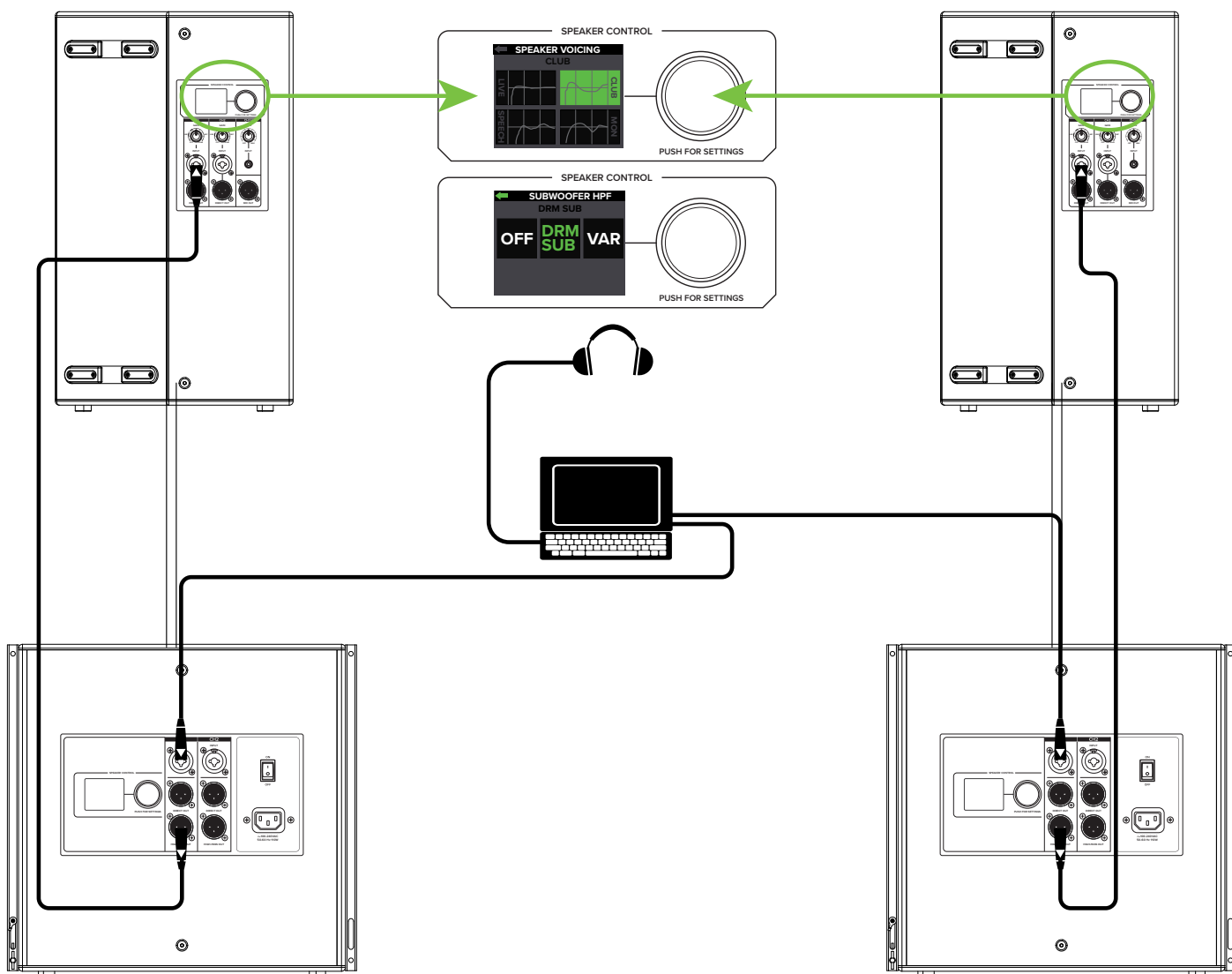

Perhaps you're a DJ playing bumpin' tunes in the middle of the night to a crowd that's groovin' and dancin' to your fine selection.

In this example, a laptop is connected to the inputs of two DRM18S subwoofers with the X-Over set to DRM Top.

The High-Pass Out of each subwoofer is then connected to the input of each DRM212 loudspeaker. Additionally, a set of Mackie MC-250 headphones is connected to the phones jack of the laptop.

The Speaker Modes of both loudspeakers may be set to Club and the Subwoofer HPF set to DRM Sub.

## Hookup Diagrams continued...

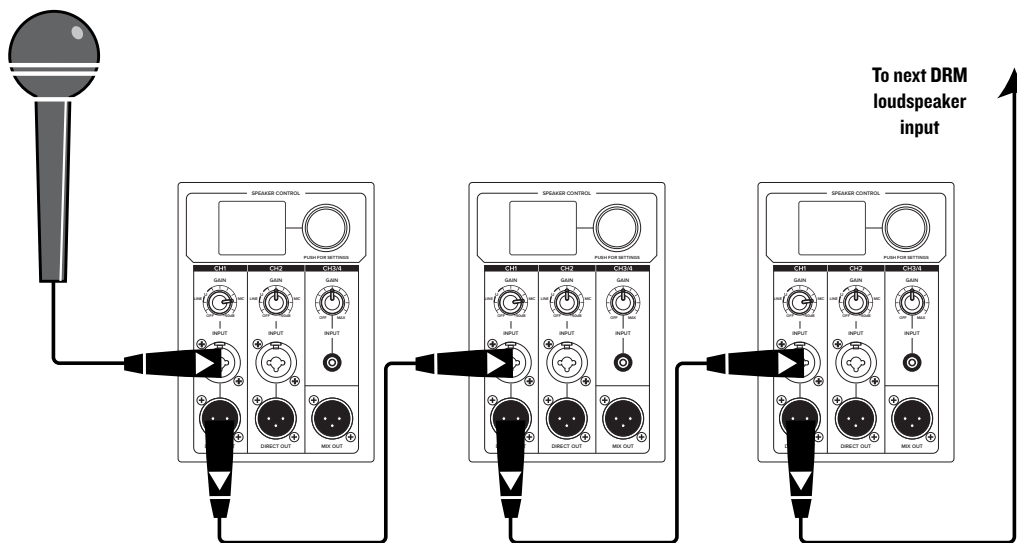
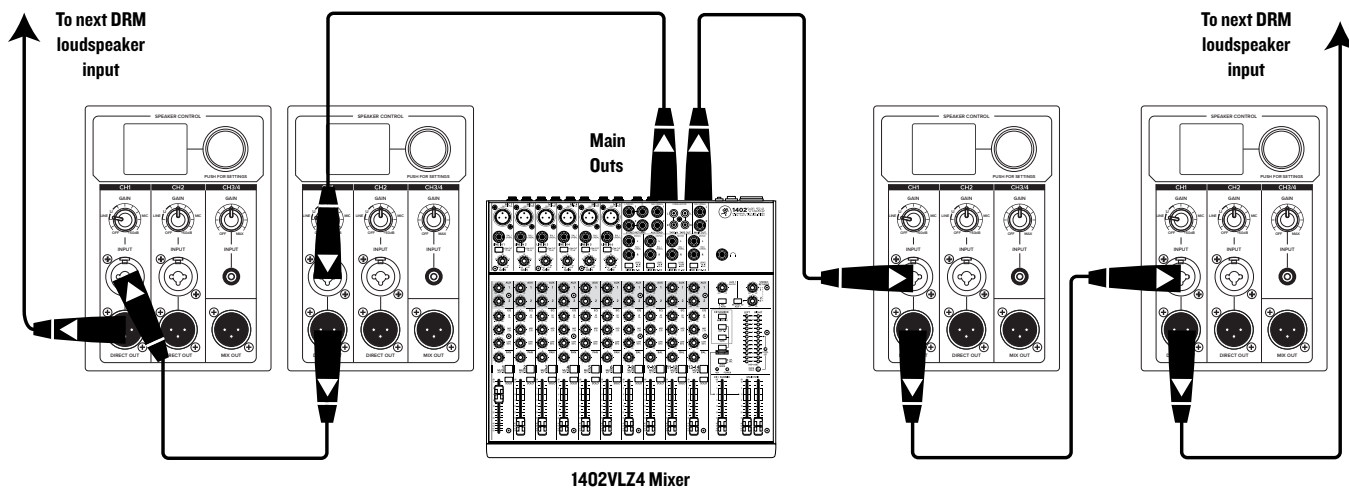

DRM loudspeakers may be daisy-chained via the male XLR connector labeled “DIRECT OUT” (which sends only the signal from the input located above it) or via the “MIX OUT” which outputs all inputs. Simply plug the signal source (i.e., mixer output or microphone) into the input jack(s), and patch that loudspeaker’s direct out or mix out jack to the next loudspeaker’s input jack, and so on, daisy-chaining multiple DRM loudspeakers. See above for visual representations of daisy-chaining.

### Daisy-Chaining Multiple DRM Loudspeakers



Hookup Diagrams continued...

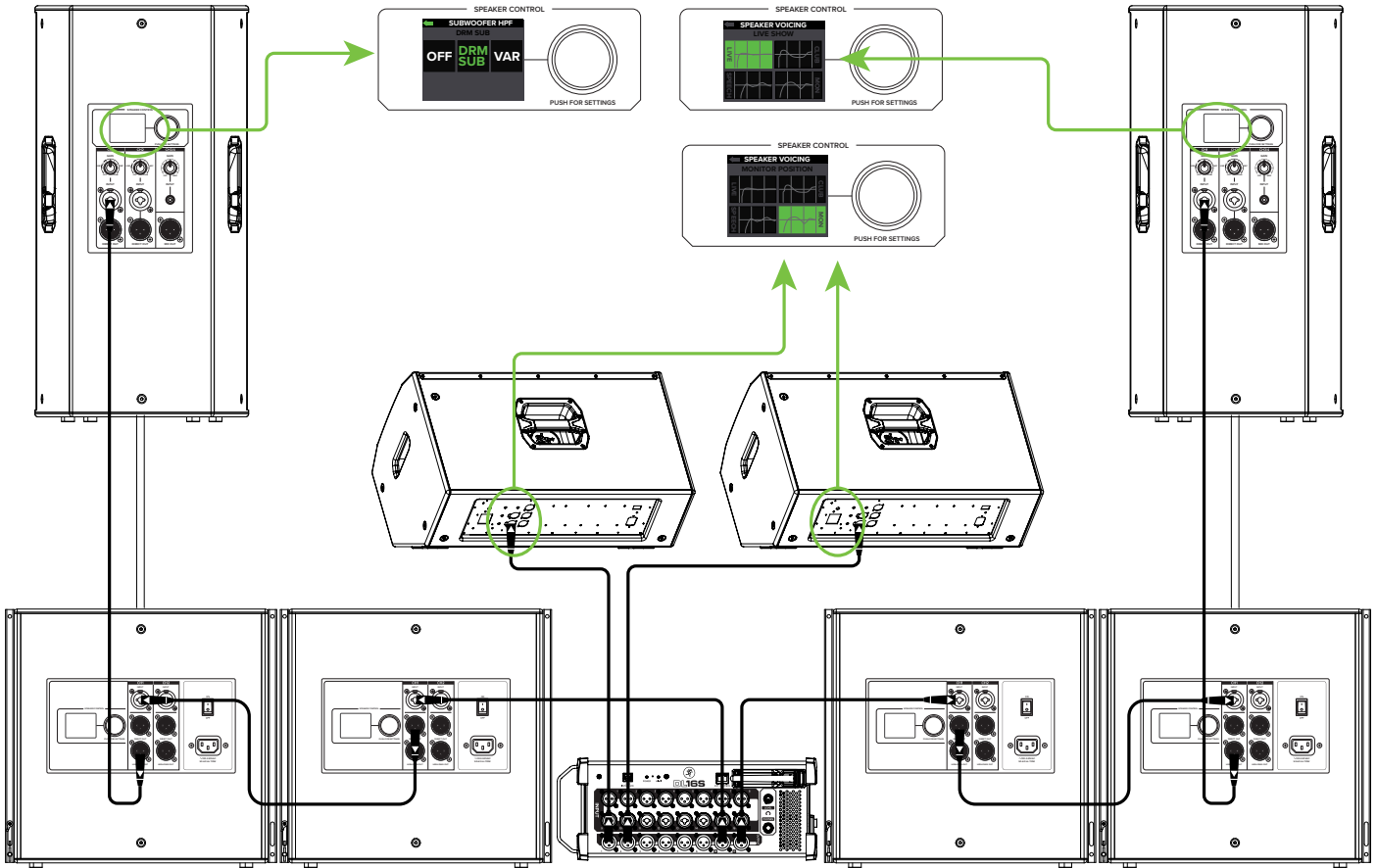

Here's how to set up a large club system. In this example, the L/R outputs of a DL16S mixer are connected directly to the CH1 inputs of a pair of DRM18S subwoofers. The Direct Out of each subwoofer is then connected to the inputs of an additional pair of DRM18S subwoofers. The X-Over of these subwoofers may be set to DRM Top.

From here, the high-pass outputs of the two outer DRM18S subwoofers are connected directly to the inputs of a set of DRM315 loudspeakers. The Speaker Modes of these PA loudspeakers may be set to Live (or Club) and the Subwoofer HPF set to DRM Sub. Talk about beefy low end!

Outputs 1 and 2 from the mixer may be used as aux sends; these are connected directly to the CH1 inputs of a pair of DRM212 loudspeakers to be used as monitors for the band. The Speaker Modes of the monitor loudspeakers may be set to Monitor.

Large Club System

# DRM Loudspeakers: Rear Panel Features

## 1. Power Connection

This is a standard 3-prong IEC power connector. Connect the detachable power cord (included in the packaging with the loudspeaker) to the power receptacle, and plug the other end of the power cord into an AC outlet.



Make sure that the AC power is matched to the AC power indicated on the rear panel (below the IEC receptacle).



Disconnecting the plug's ground pin is dangerous. Don't do it!

## 2. Power Switch

Press the top of this rocker switch inwards to turn on the loudspeaker. Press the bottom of this rocker switch inwards to turn off the loudspeaker.



As a general guide, the mixer (or other signal source) should be turned on first, subwoofers next, and loudspeakers last.

As such, the loudspeakers should also be turned off first, followed by the subwoofers, then the mixer. This will reduce the possibility of any turn-on or turn-off thumps and other noises generated by any upstream equipment from coming out of the speakers.

## 3. XLR and 1/4" Combo Inputs [Ch. 1 and 2]

Input channels 1 and 2 may accept a balanced mic signal using an XLR connector. They are wired as follows, according to standards specified by the AES (Audio Engineering Society).

### XLR Balanced Wiring:

- Pin 1 = Shield (ground)
- Pin 2 = Positive (+ or hot)
- Pin 3 = Negative (- or cold)

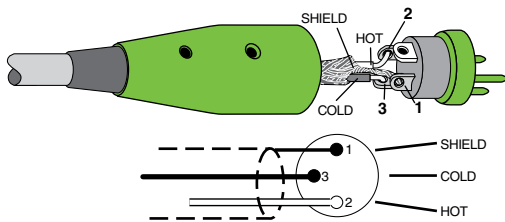

In addition to accepting a balanced mic signal using an XLR connector, these input channels may also accept 1/4" line-level signals driven by balanced or unbalanced sources.

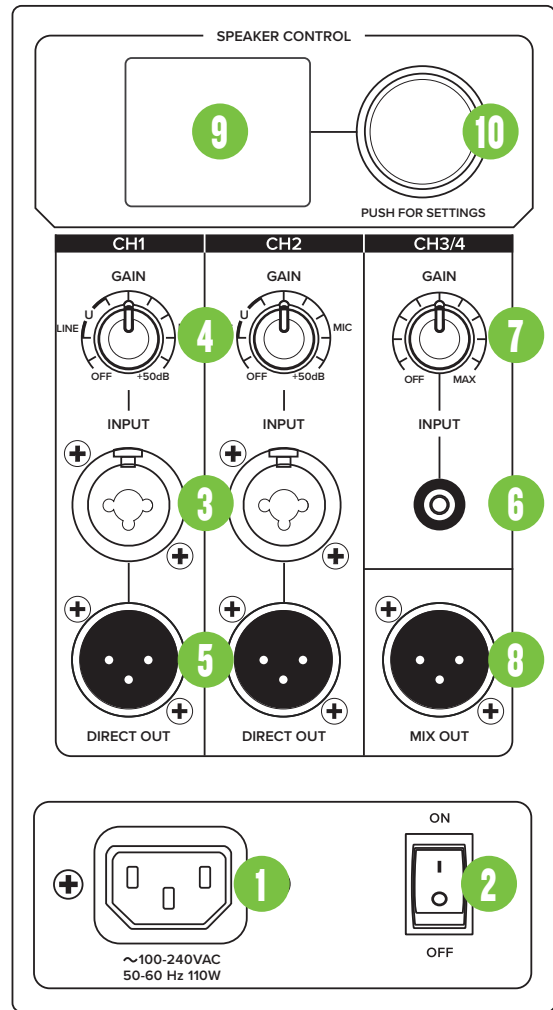

Also, channel 2 may accept a Hi-Z source (such as a guitar) via the 1/4" input without the need for a separate DI box. Be sure to set the Ch. 2 In to Hi-Z in the Configuration menu, though! Directions on page 17.

To connect balanced lines to these inputs, use a 1/4" Tip-Ring-Sleeve (TRS) plug. "TRS" stands for Tip-Ring-Sleeve, the three connection points available on a stereo 1/4" or balanced phone jack or plug. TRS jacks and plugs are used for balanced signals and are wired as follows:

### 1/4" TRS Balanced Mono Wiring:

- Sleeve = Shield
- Tip = Hot (+)
- Ring = Cold (-)

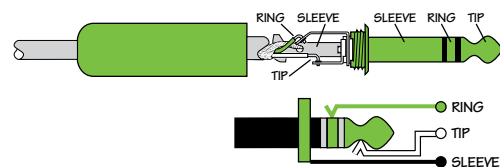

## DRM Loudspeakers: Rear Panel Features continued...

To connect unbalanced lines to these inputs, use a 1/4" mono (TS) phone plug, wired as follows:

### 1/4" TS Unbalanced Mono Wiring:

Sleeve = Shield  
Tip = Hot (+)

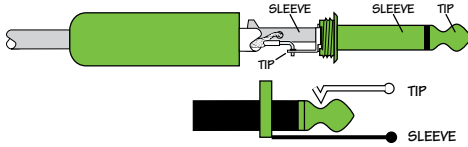

**NEVER** connect the output of an amplifier directly to a DRM's input jack. This could damage the input circuitry!

### 4. Gain [Ch. 1 and 2]

The gain knobs adjust the input sensitivity of the mic/line inputs. This allows signals from the outside world to be adjusted to run through each channel at optimal internal operating levels.

There is  $-\infty$  dB of gain with the knob fully down (off), ramping up to +50 dB of gain fully up (max).



If connecting mixer outputs to loudspeaker inputs, set the gain knob to 10:00 ["U"] for optimal sound and performance.

### 5. Direct Out [Ch. 1 and 2]

This is a male XLR-type connector that produces exactly the same signal that is connected to the input jack located above it. Use it to daisy-chain several DRM loudspeakers together off the same signal source(s).

They are wired as follows, according to standards specified by the AES (Audio Engineering Society):

#### Balanced XLR Output Connector

Pin 1 – Shield (ground)  
Pin 2 – Positive (+ or hot)  
Pin 3 – Negative (- or cold)

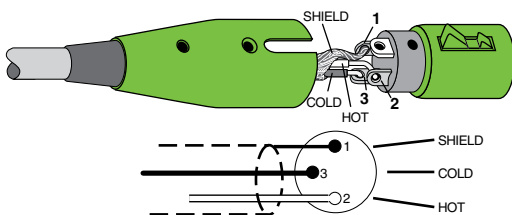

See page 8 to learn more about daisy-chaining DRM loudspeakers.

### 6. 1/8" Input [Ch. 3/4]

This input may accept a stereo 1/8" line-level signal from a phone, tablet, MP3 player, or other signal source.



**NEVER** connect the output of an amplifier directly to this input jack. This could damage the input circuitry.

### 7. Gain [Ch. 3/4]

This gain knob adjusts the input sensitivity of the 1/8" stereo input. This allows signals from the outside world to be adjusted to run at optimal internal operating levels. It ranges from off (knob fully down) up to max (knob fully up).

### 8. Mix Out

This is a male XLR-type connector that produces the same signal from all three input jacks (with Ch. 3/4 mono-summed). Use it to daisy-chain several DRM loudspeakers together off the same signal source(s).

It is wired the same as the direct outputs as seen to the left.

### 9. LCD Display

This modern, high-resolution, all-color TFT LCD Display is one of the most vital features of the DRM loudspeaker. It displays loudspeaker information including (but not limited to) levels, EQ, selected voicing, settings, lock / unlock status and other parameters.



The brightness is controllable, but an overall screen brightness is required for certain aspects of the set-up options.

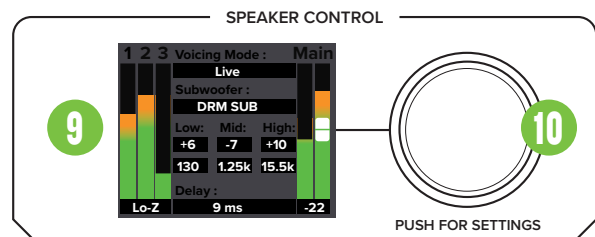

### 10. Speaker Control Knob

This push-button rotary encoder allows you to access functions such as channel and master level control and metering, application specific voicings & EQ, setup functions, product information and much more!

## DRM Control Dashboard™

The following list provides the high level navigation items, in order, on the user interface and their subsequent user controlled parameters.

The default screen is the main view, as seen below:

**Main** – This displays the I/O metering, voicing mode, subwoofer HPF selection, EQ and delay settings and more. The only thing that may be changed here is the main output level.

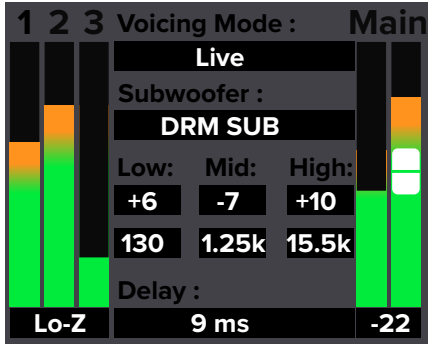

**Menu** – The menu provides icon selectors for all user-controllable functions with most of these containing an array of sub-menus.

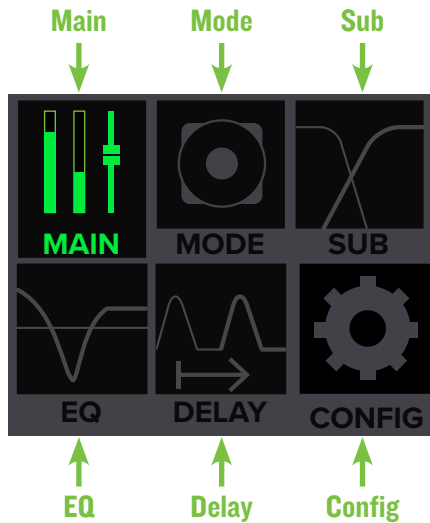

We will go through each, how to get there and how to change settings.

After a selection is made, the LCD screen will revert back to the Main screen after 5 seconds of (speaker control) inactivity. You yourself may continue to be as active (or inactive) as you want.

Rotate the speaker control knob to navigate between the selections and push the button to open and edit the parameters.

### Main

Push the speaker control knob to open the menu. From here, rotate the speaker control knob to scroll between the six selections. The current selection will illuminate in a can't-miss DayGlo green.

The first choice here is main. Push the button when main is illuminated to open it.

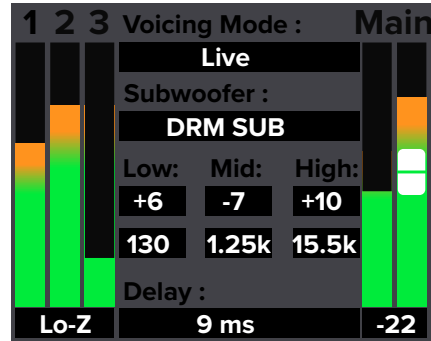

As you can see here, this is the same exact look as the default main screen. Like the default main screen, here you can only update the main output level. Do so by turning the speaker control knob clockwise (louder) and counter-clockwise (quieter). Once the level you desire has been dialed in, press the speaker control knob again to return to the main screen.

Let's expand on the meters for a moment. The peak holder meter peaks at +16 dBu and a 4:1 compressor engages at approximately +8 dBu. This means that the loudspeaker is compressing when the peak/hold indicator is hitting the top of the meter scale. It also signifies that you are nearing the end of available headroom. As you continue to raise the volume, you're continuing to compress the signal, as well. This is reflected in compression of the metering – which will remain at or near the top of the meter strip – and reflected in the acoustic output.

The main level control range is as follows:

- Main Output:  $-\infty$  dB (off) to unity (max)

### Speaker Mode

Speaker mode allows you to change the loudspeaker's speaker voicing to tailor it to best suit your particular application.



The four speaker modes are as follows:

- Live – This mode is flat, perfect for singer-songwriters and other live performers.

- **Club** – This mode is full range, but focuses on increased bass and brilliant high frequencies. This is the place to start for most DJ / music playback applications.

- **Speech** – This mode features a significant low frequency roll-off to get rid of unwanted thumps. It also adds boost and sparkle to mid-range and high frequencies, critical for speech applications.

This plug-and-play mode is perfect for larger venue applications where speech is the primary audio source in need of clear and precise intelligibility.

- **Monitor** – This mode features a low frequency roll-off and a reduction around 2 kHz to ensure maximum gain before feedback in monitor applications.

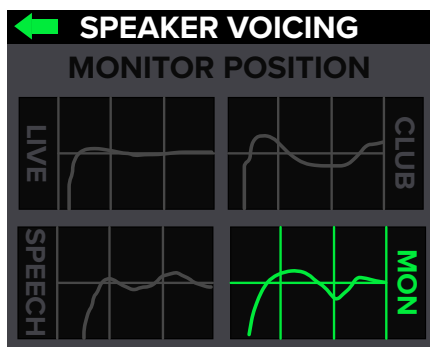
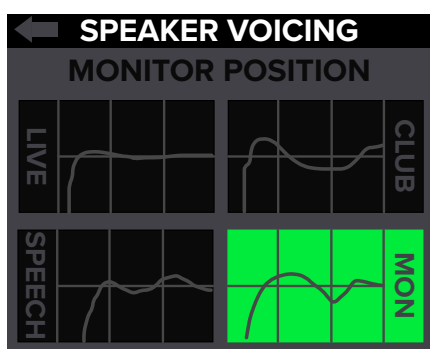

Simply rotate the speaker control knob until the speaker mode you desire is illuminated, then push to select it. As seen above, we selected Monitor.

In addition to the four speaker modes, there's a fifth and final selection: the left-facing arrow. Illuminating and selecting this simply returns you to the menu.

## Sub

You're our hero, so we have a built-in submarine sandwich maker! After pushing the speaker control knob in to select sub, you will be presented with a multitude of choices, including:

- Cold Cut
- Roast Beef
- Philly Cheesesteak
- BLT
- Meatball
- Veggie
- Tuna
- Design Your Own

Now that you're hungry, let's take a look at what opening the sub menu really displays:

- **Off** – Choose this if there is no subwoofer connected to the system. Here you are using DRM loudspeakers only.

- **DRM Sub** – Choose this if a Mackie DRM18S subwoofer is connected to the system. The crossover point is set to 90 Hz to work in perfect harmony with the Mackie DRM18S Sub. This is what we hope you choose, thank you for your support!

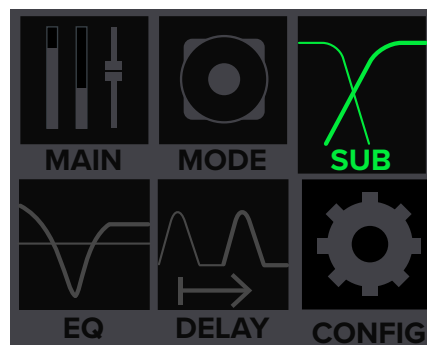

- **Var** – Choose this if a non-Mackie DRM18S subwoofer is connected to the system. Here you can select the subwoofer's HPF, ranging from 40 Hz – 160 Hz.

Rotate the speaker control knob until the sub HPF you desire is illuminated, then push to select it. If var is selected (as seen below), the frequency is illuminated and may be changed by rotating the speaker control knob clockwise (raise the frequency) and counter-clockwise (lower the frequency).

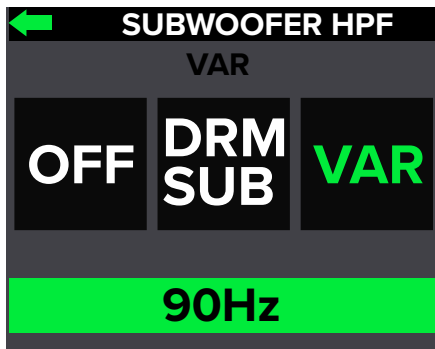
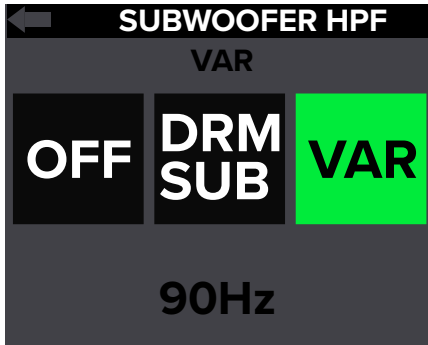

In addition to the three sub modes, there's a fourth and final selection: the left-facing arrow. Illuminating and selecting this simply returns you to the menu.

**EQ Setup**

On to the bottom row now! The first one listed is EQ, and, as you might expect, this is where to adjust the output EQ.

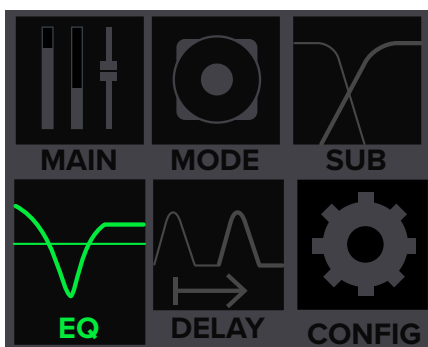

The DRM212, DRM215 and DRM315 all have 3-band EQ with shelving hi, peaking mid and shelving low. Shelving means that the circuitry boosts or cuts all frequencies past the specified frequency. Peaking means that certain frequencies form a "hill" around the center frequency.



With too much EQ, you can really upset things. We've designed a lot of boost and cut into the equalizer circuit because we know that everyone will occasionally need that. But if you max the EQ, you'll get mix mush.

In order to change the EQ, first push the speaker control knob when the EQ icon is illuminated (see image above). This opens the EQ view:

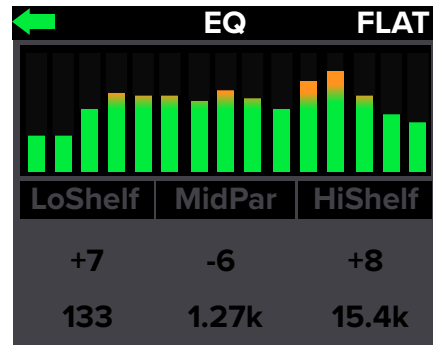

From here, rotate the speaker control knob until the parameter you want to change is illuminated. Push the speaker control knob in to select the parameter followed by rotating the speaker control knob clockwise (raise the gain / frequency) and counter-clockwise (lower the gain / frequency).

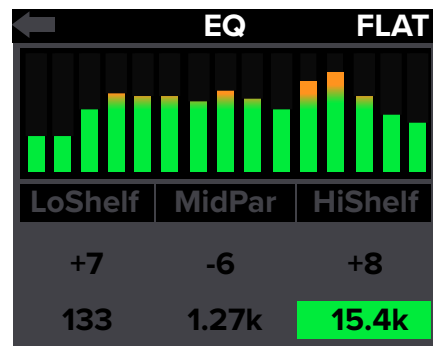

The EQ ranges are as follows:

- Low: ±12 dB @ 20 Hz – 200 Hz
- Mid: ±12 dB @ 200 Hz – 2.00 kHz
- High: ±12 dB @ 2.00 kHz – 20.0 kHz



In addition to these EQ choices, there are two more selections. First, when flat is illuminated and selected (by pushing in the speaker control knob), the EQ resets to flat:

- Low: ±0 dB (unity) @ 100 Hz
- Mid: ±0 dB (unity) @ 1.00 kHz
- High: ±0 dB (unity) @ 10.0 kHz

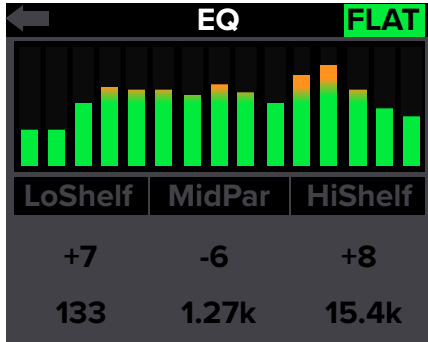

Like the previous sub-menus, the EQ also has a left-facing arrow. Illuminating and selecting this simply returns you to the menu.

Let's talk about those meters now. That is what's called a "Real-Time Analyzer" [RTA for short]. It measures and displays the sound of the corresponding output – amplitude versus frequency components of a continuous signal – via DSP.

An RTA allow you to see what you hear so you may easily locate and eliminate feedback and other anomalies while seeing the EQ changes in real time.

Many audio signals are highly dynamic: music, speech and even environmental noise contain significant changes in spectral content as a function of time. With a digital mixer, musicians and sound engineers can save time setting up at shows by recalling previous settings. The DRM's RTA fits right in with that, literally displaying frequencies, shortening the time it takes to tune the main loudspeakers or stage monitors during setup in a new room.

There are 15 bands on all DRM Series RTAs.

**Delay**

Probably the easiest parameter to describe and update. This controls the monitor delay. In other words, you are going to want to time-align the speakers throughout the venue so the sound hits everywhere simultaneously. This is the place.

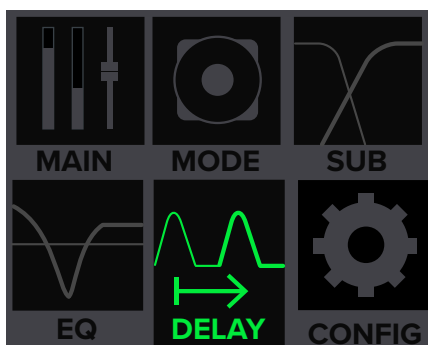

The delay time ranges from a low of 0.0 ms (ft, m) to a maximum of 100 ms (112.5 ft, 34.2 m).

In order to change the delay, first push the speaker control knob when the delay icon is illuminated (see image above). This opens the delay view.

From here, rotate the speaker control knob clockwise until the ms parameter is highlighted.



This is the only parameter that can be changed here; the ft and m delay time ranges update automatically dependent on where ms is set.

Push the speaker control knob in to select the ms parameter followed by rotating the speaker control knob clockwise (raise the delay time) and counter-clockwise (lower the delay time).

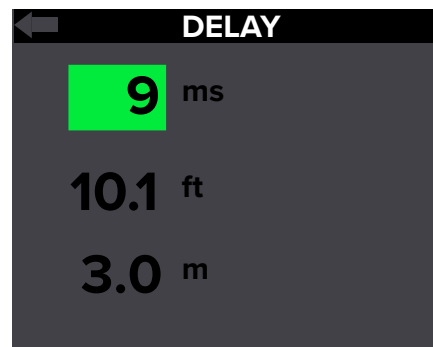
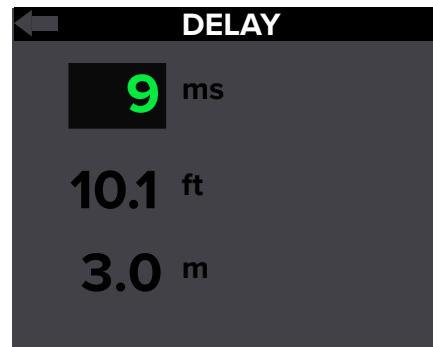

Like the previous sub-menus, the delay also has a left-facing arrow. Illuminating and selecting this simply returns you to the menu.

**Configuration**

This is where to recall / store settings to memory, lock access to the settings, select Ch. 2 input setting and more.

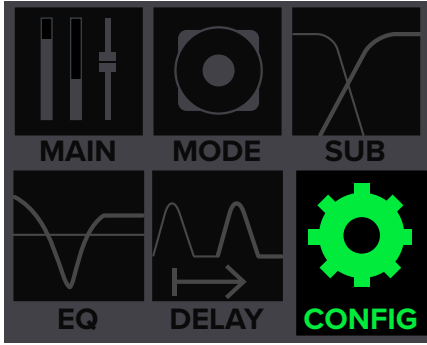

This is similar to what you will see after first entering the configuration screen. The current Ch2 in, backlight and front LED settings will be illuminated.

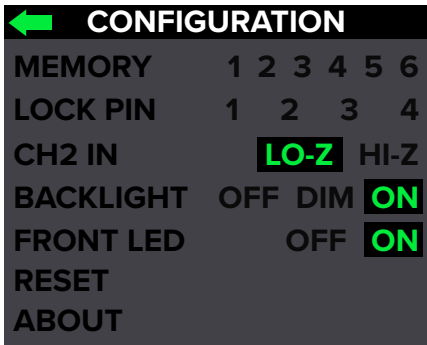

To change a setting, just rotate the speaker control knob until the configuration you desire to change is illuminated, then push to select it.

These are the choices from top to bottom:

**Memory** – When memory is selected, settings may be saved to memory and recalled at a later time. No more having to reset levels, EQ, voicing, etc. upon every power-up.

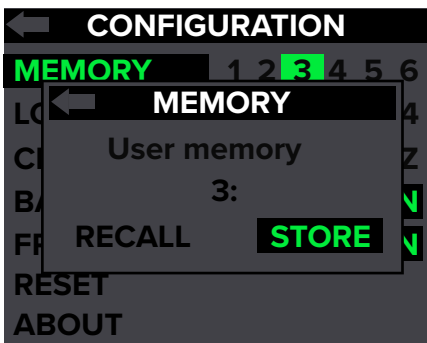
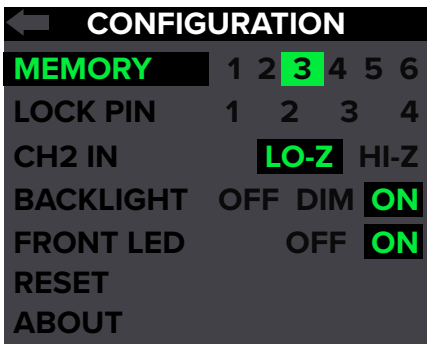

There are six user memory snapshots which should be more than enough.

**Store** – Tap this to store the current settings to the corresponding memory snapshot.



Please be aware that the new settings will replace the currently saved settings.

**Recall** – Tap this to recall the settings of the selected memory snapshot.

Illuminating and selecting the left-facing arrow returns you to the previous screen.

**Lock Pin** – This is where to lock and unlock the interface with a secret 4-digit numeric password.

Rotate the speaker control knob until lock pin is illuminated, then push in to enter lock mode. From here, rotate the speaker control knob until the first number you desire is illuminated and press to select. Follow the same procedure for the next three numbers.

As seen below, we decided to go with 1-2-3-4 because that's (a "5" shy of) the same code that was used on Spaceballs. A confirmation dialog helps prevent accidents. No further changes may be made until the control access is unlocked.

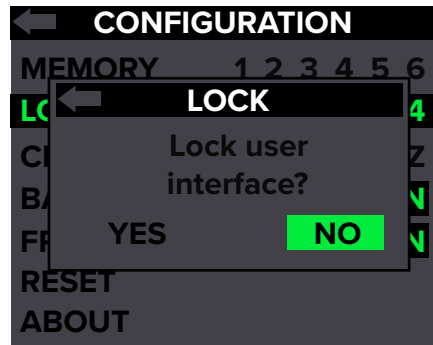
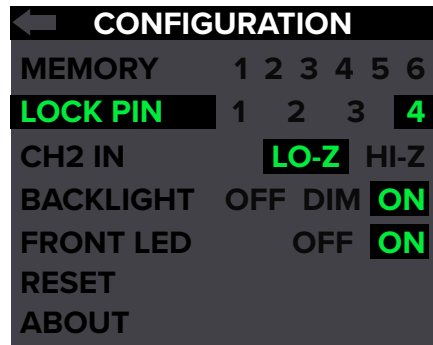

**Unlocking** – If you try to make any changes or select anything, you will be asked to enter the pin. Here you will need to re-enter the 4-digit code and push the speaker control knob to unlock.

**Secret Squirrel Unlock** – If you – or worse, someone else! – set up a 4-digit lock code and you don't know the passcode, there is a quick fix. Simply press and hold down the speaker control knob down for a few seconds and it will automatically unlock.

Illuminating and selecting the left-facing arrow returns you to the previous screen.

**Ch 2 in** – The channel 2 input allows instruments to be connected directly into the 1/4" jack. To connect an instrument directly without using a DI Box, change the channel 2 input setting to Hi-Z first. The Hi-Z text will illuminate to indicate that Hi-Z is active. Then connect the output from the instrument to the channel 2 1/4" TRS input. The input impedance is optimized for direct connection and high-frequency fidelity is assured.

Guitars may sound dull and muddy without a DI box or if Hi-Z is not engaged. When set at Lo-Z, the channel 2 1/4" TRS input become a line input.

**Front LED** – Decide if you want the front LED on or off. When illuminated, push the speaker control knob to select between on or off.

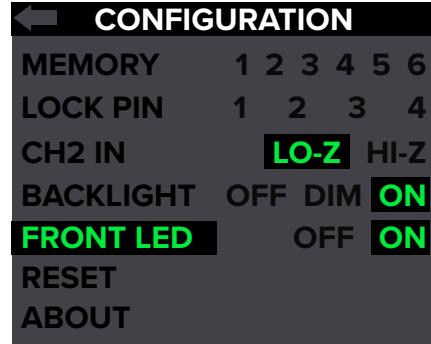

Like the previous sub-menus, configuration also has a left-facing arrow. Illuminating and selecting this simply returns you to the menu.

**Reset** – Resets all parameters back to their factory default. This is a permanent reset with no undo, so a confirmation dialog helps prevent accidents.

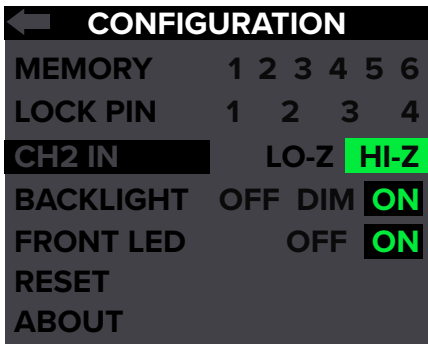

Illuminating and selecting the left-facing arrow returns you to the previous screen.

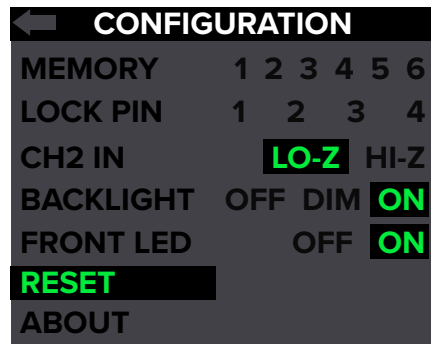

**NOTE** More information about channel 2's Hi-Z input may be found on page 10.

**Backlight** – The fourth configuration setting that may be changed is the brightness – or lack thereof – of the LCD screen.

There are three choices: off, dim and on.

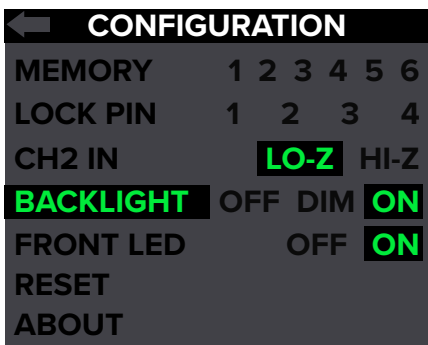

Illuminating and selecting the left-facing arrow returns you to the previous screen.

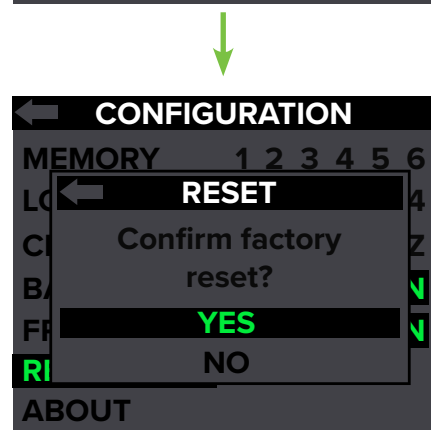
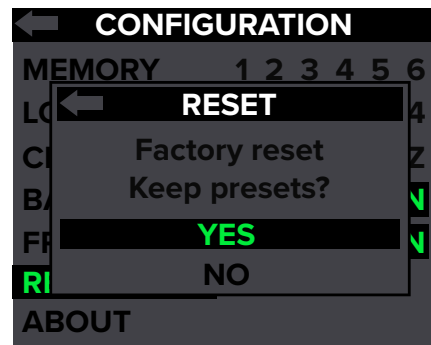



The screen displayed on the previous page and again below may be of particular interest. Yes, it's true – you CAN do a factory reset and either choose to save your user presets or not!

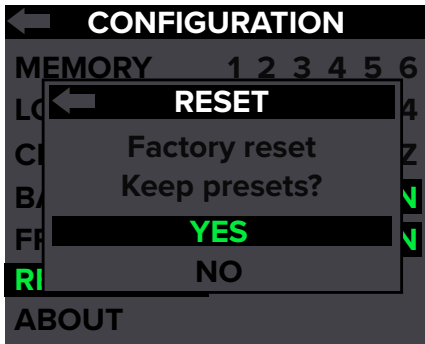

Illuminating and selecting the left-facing arrow returns you to the previous screen.

**About** – Displays the current information about your loudspeaker, including the model, firmware and DSP versions, temperature and favorite color. There is really only one reason to go here and that is if you've been directed so by Technical Support.

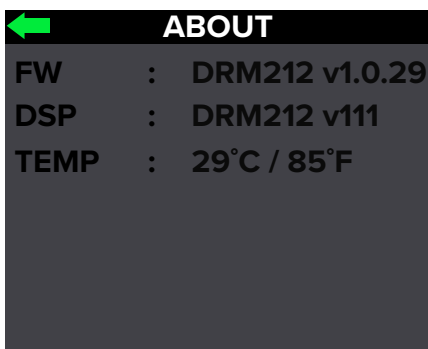
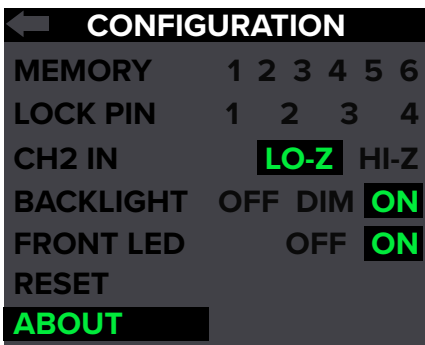

## Protection Circuitry

DRM loudspeakers employ a built-in limiter for less distortion at peak levels. A dynamic bass response circuit provides optimal low frequency response regardless of overall output level. Additional protection includes automatic thermal shutdown should the amp overheat. However, with Class-D amp technology, which is highly-efficient, this should never be a problem.



The protection circuits are designed to protect the loudspeakers under reasonable and sensible conditions. Should you choose to ignore the warning signs [e.g. excessive distortion], you can still damage the speaker in the loudspeaker by overdriving it past the point of amplifier clipping. Such damage is beyond the scope of the warranty.

### Limiting

The driver has its own compression circuit which helps protect it from damaging transient peaks. The compressor is designed to be transparent and is not noticeable under normal operating conditions.

### Overexcursion Protection

A subsonic filter circuit just prior to the power amplifier prevents ultra-low frequencies from being amplified. Excessive low-frequency energy can damage the woofer by causing it to “bottom out,” also know as overexcursion, which is equivalent to a mechanical form of clipping.

### Thermal Protection

All amplifiers produce heat. DRM loudspeakers are designed to be efficient both electrically and thermally. In the unlikely event of the amplifier overheating, a built-in thermal switch will activate, muting the signal.

When the amplifier has cooled down to a safe operating temperature, the thermal switch resets itself, and the DRM loudspeaker resumes normal operation.

If the thermal switch activates, try turning down the level control a notch or two on the mixing console (or via the Speaker Control knob) to avoid overheating the amplifier. Be aware that direct sunlight and/or hot stage lights may be the culprit of an amplifier overheating.

## AC Power

Be sure the DRM loudspeaker is plugged into an outlet that is able to supply the correct voltage specified for your model. It will continue to operate at lower voltages, but will not reach full power. Be sure the electrical service can supply enough amperage for all the components connected to it.

We recommend that a stiff (robust) supply of AC power be used because the amplifiers place high current demands on the AC line. The more power that is available on the line, the louder the speakers will play and the more peak output power will be available for a cleaner, punchier bass. A suspected problem of “poor bass performance” is often caused by a weak AC supply to the amplifiers.



Never remove the ground pin on the power cord or any other component of the DRM loudspeaker. This is very dangerous.

## Care and Maintenance

Your DRM loudspeakers will provide many years of reliable service if you follow these guidelines:

- Avoid exposing the loudspeakers to moisture. If they are set up outdoors, be sure they are under cover if rain is expected.
- Avoid exposure to extreme cold (below freezing temperatures). If you must operate the loudspeakers in a cold environment, warm up the voice coils slowly by sending a low-level signal through them for about 15 minutes prior to high-power operation.
- Use a dry cloth to clean the cabinets. Only do this when the power is turned off. Avoid getting moisture into any of the openings of the cabinet, particularly where the drivers are located.

## Placement



**WARNING:** Installation should only be done by an experienced technician. Improper installation may result in damage to the equipment, injury or death. Make sure that the loudspeaker is installed in a stable and secure way in order to avoid any conditions that may be dangerous for persons or structures.

DRM loudspeakers are designed to sit on the floor or stage as the main PA or as monitors. They may also be pole-mounted via the built-in socket on the bottom of the cabinet. Be sure the pole is capable of supporting the weight of the loudspeaker. The SPM400 is a great option when using a subwoofer.

These loudspeakers may also be flown via their integrated fly points as detailed on the following pages. Be sure to read the PA-A2 Eyebolt Installation Instructions, as well.



**NEVER** attempt to suspend a DRM loudspeaker by its handles.

Check to make sure that the support surface (e.g. floor, etc.) has the necessary mechanical characteristics to support the weight of the loudspeaker(s).

When pole-mounting loudspeakers, be sure that they are stabilized and secured from falling over or being accidentally pushed over. Failure to follow these precautions may result in damage to the equipment, personal injury, or death.

The DRM212 and DRM215 have dual angle pole-mounts for optimal coverage. The rear one is a straight angle while the front is angled at a 7° downward tilt. Additionally, these two models may be laid out horizontally as monitors for the band at a 50° angle (as seen below).

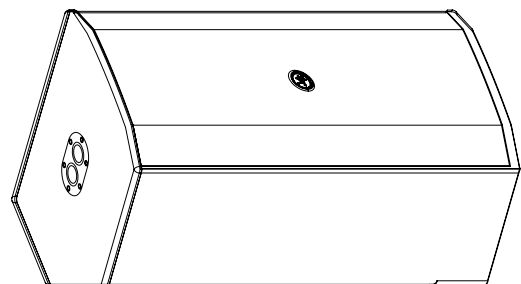

The Running Man logo is rotatable for when the DRM212 or DRM215 is used as a monitor; you can also rotate it when the DRM315 is flown horizontally!

As with any powered components, protect them from moisture. Avoid installing the loudspeaker in places exposed to harsh weather conditions. If you are setting them up outdoors, make sure they are under cover if you expect rain.

**Room Acoustics**

DRM loudspeakers are designed to sound fantastic in nearly every application.

But, room acoustics play a crucial role in the overall performance of a sound system. However, the wide high-frequency dispersion of the DRM loudspeakers helps to minimize the problems that typically arise.

Here are some additional placement tips to help overcome some typical room problems that might arise:

- Placing loudspeakers in the corners of a room increases the low frequency output and can cause the sound to be muddy and indistinct.
- Placing loudspeakers against a wall increases the low frequency output, though not as much as corner placement. However, this is a good way to reinforce the low frequencies, if so desired.
- Avoid placing the speakers directly on a hollow stage floor. A hollow stage can resonate at certain frequencies, causing peaks and dips in the frequency response of the room. It is better to place them on a sturdy stand designed to handle the weight of the loudspeaker.
- Position the loudspeakers so the high-frequency drivers are two to four feet above ear level for the audience (making allowances for an audience that may be standing/dancing in the aisles). High frequencies are highly directional and tend to be absorbed much easier than lower frequencies. By providing direct line-of-sight from the loudspeakers to the audience, you increase the overall brightness and intelligibility of the sound system.

• Highly reverberant rooms, like many gymnasiums and auditoriums, are a nightmare for sound system intelligibility. Multiple reflections off the hard walls, ceiling, and floor play havoc with the sound. Depending on the situation, you may be able to take some steps to minimize the reflections, such as putting carpeting on the floors, closing draperies to cover large glass windows, or hanging tapestries or other materials on the walls to absorb some of the sound.

However, in most cases, these remedies are not possible or practical. So what do you do? Making the sound system louder generally doesn't work because the reflections become louder, too. The best approach is to provide as much direct sound coverage to the audience as possible. The farther away you are from the speaker, the more prominent will be the reflected sound.

Use more speakers strategically placed so they are closer to the back of the audience. If the distance between the front and back speakers is more than about 100 feet, you should use either (1) the internal delay processor via the speaker control knob (see page 15), or (2) use an external delay processor to time-align the sound. (Since sound travels about 1 foot per millisecond, it takes about 1/10 of a second to travel 100 feet.)

Keep in mind that the speaker mode is another great way to compensate for some of these issues. See page 12 for more information.

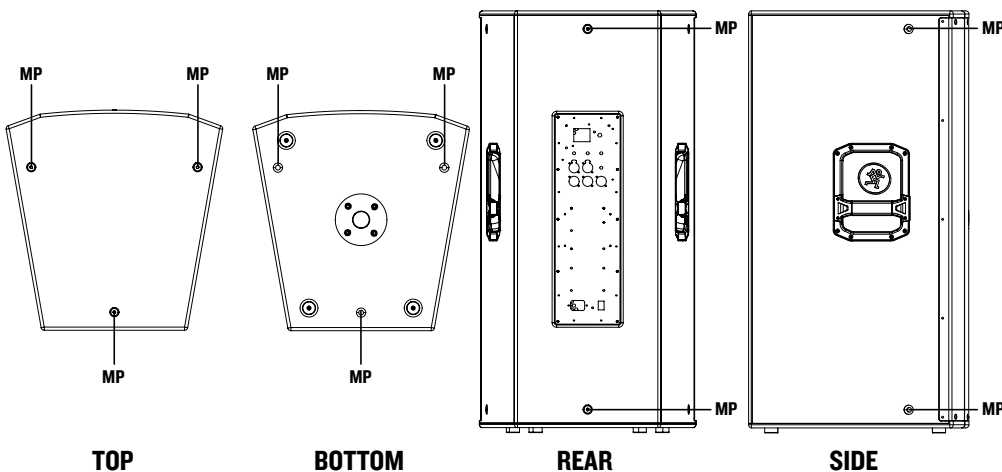
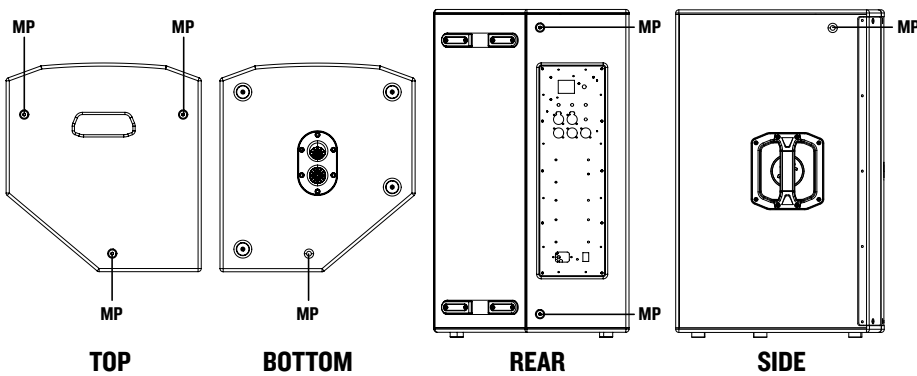



## Rigging



**WARNING:** Installation should only be done by an experienced technician. Improper installation may result in damage to the equipment, injury or death. Make sure that the loudspeaker is installed in a stable and secure way in order to avoid any conditions that may be dangerous for persons or structures.



**WARNING:** The cabinet is suitable for rigging via its fly points. **NEVER** attempt to suspend a DRM loudspeaker by its handle.

The fly points of the DRM212, DRM215 and DRM315 are shown on the previous page while examples of a flown DRM315 are displayed below.



The DRM315 may be flown horizontally or vertically, but the DRM212 and DRM215 may only be flown vertically.

### Rigging Design Practices

Rigging a loudspeaker requires determining:

1. The rigging methods and hardware that meet static, shock, dynamic, and any other load requirements for supporting the loudspeaker from structure.

2. The design factor and required WLL (Working Load Limit) for this support.

We strongly recommend the following rigging practices:

1. Documentation: Thoroughly document the design with detailed drawings and parts lists.

2. Analysis: Have a qualified professional, such as a licensed Professional Engineer, review and approve the design before its implementation.

3. Installation: Have a qualified professional rigger do the installation and inspection.

4. Safety: Use adequate safety precautions and back-up systems.

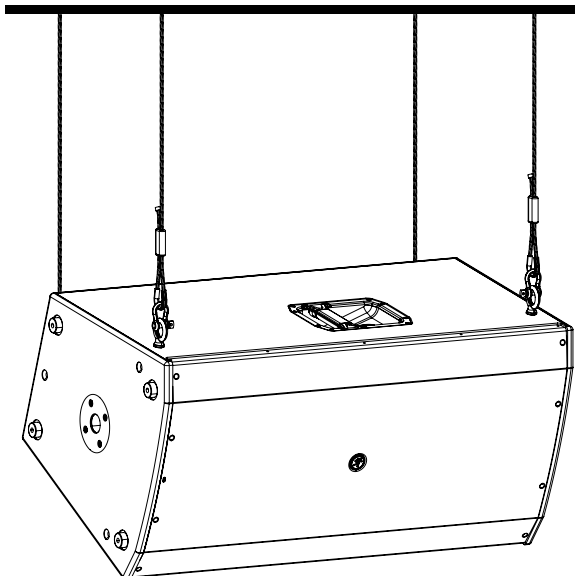

### Rigging Hardware and Accessories

Rigging our loudspeakers will invariably require hardware not supplied by us. Various types of load-rated hardware are available from a variety of third-party sources. There are a number of such companies specializing in manufacturing hardware for designing and installing rigging systems. Each one of these tasks is a discipline in its own right. Because of the hazardous nature of rigging work and the potential liability, engage companies that specialize in these disciplines to do the work required.

We do offer certain accessory rigging items and some of them may be used with a variety of products. While these accessories are intended to facilitate installation, the wide variety of possible installation conditions and array configurations do not permit us to determine their suitability or load rating for any particular application.

We are not in the business of providing complete rigging systems, either as designers, manufacturers, or installers. It is the responsibility of the installer to provide a properly engineered, load-certified rigging system for supporting the loudspeaker from structure.



DRM loudspeakers may be individually flown using a PA-A2 Eyebolt Kit, part number 2051054.

### Rigging Notes

The DRM loudspeaker's integral mounting points are designed to support only the weight of their own loudspeaker with suitable, external hardware. This means that each DRM loudspeaker must be supported independently of any other DRM loudspeaker and any other loads. At least three rigging points must be used to hang each DRM loudspeaker.

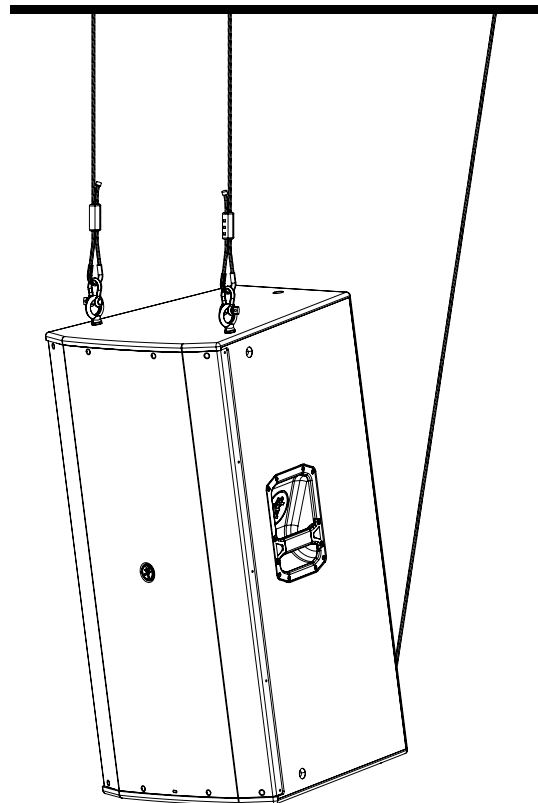

## Appendix A: Service Information

If you think your DRM loudspeaker has a problem, please check out the following troubleshooting tips and do your best to confirm the problem. Visit the Support section of our website ([www.mackie.com/support](http://www.mackie.com/support)) where you will find lots of useful information such as FAQs and other documentation. You may find the answer to the problem without having to part with your loudspeaker.

### Troubleshooting

#### No power

- Our favorite question: Is it plugged in? Make sure the AC outlet is live [check with a tester or lamp].
- Our next favorite question: Is the power switch on? If not, try turning it on.
- Make sure the line cord is securely seated in the line cord socket and plugged all the way into the AC outlet.
- Is the power LED on the front panel illuminated? If not, make sure the AC outlet is live. If so, refer to “No sound” below.
- The internal AC line fuse may be blown. This is not a user serviceable part. If you suspect the AC line fuse is blown, please see the “Repair” section next.

#### No sound

- Is the level knob for the input source turned all the way down? Verify that all the volume controls in the system are properly adjusted. Look at the level meter to ensure that the mixer is receiving a signal.
- Is the signal source working? Make sure the connecting cables are in good repair and securely connected at both ends. Make sure the output level control on the mixing console is turned up sufficiently to drive the inputs of the speaker.
- Make sure the mixer does not have a mute on or a processor loop engaged. If you find something like this, make sure the level is turned down before disengaging the offending switch.
- Has it shut down? Make sure there is at least six inches of free space behind each DRM loudspeaker.

#### Poor sound

- Is it loud and distorted? Make sure that you're not overdriving a stage in the signal chain. Verify that all level controls are set properly.
- Is the input connector plugged completely into the jack? Be sure all connections are secure.

#### Noise

- Make sure all connections to the loudspeakers are good and sound.
- Make sure none of the signal cables are routed near AC cables, power transformers, or other EMI-inducing devices.
- Is there a light dimmer or other SCR-based device on the same AC circuit as the DRM loudspeaker? Use an AC line filter or plug the loudspeaker into a different AC circuit.

#### Hum

- Try disconnecting the cable connected to the input jack. If the noise disappears, it could be a “ground loop,” rather than a problem with the DRM loudspeaker. Try some of the following troubleshooting ideas:
  - Use balanced connections throughout your system for the best noise rejection.
  - Whenever possible, plug all the audio equipment's line cords into outlets which share a common ground. The distance between the outlets and the common ground should be as short as possible.

#### Other Issues

- Please email or call Technical Support if you are having any other issue not listed here:
  - o [mackie.com/support-contact](http://mackie.com/support-contact)
  - o 1-800-898-3211

### Repair

For warranty service, refer to the warranty information on page 27.

Non-warranty service is available at a factory-authorized service center. To locate the nearest service center, visit [www.mackie.com/support/service-locator](http://www.mackie.com/support/service-locator). Service for DRM loudspeakers living outside the United States may be obtained through local dealers or distributors.

If you do not have access to our website, please call our Tech Support department at 1-800-898-3211 (normal business hours, Pacific Time), to explain the problem. They will tell you where the nearest factory-authorized service center is located in your area.

# Appendix B: Technical Information

## DRM Loudspeakers Specifications

### Acoustic Performance

Frequency Range (-10 dB):	45 Hz - 20 kHz [DRM212] 43 Hz - 20 kHz [DRM215] 35 Hz - 20 kHz [DRM315]
Frequency Range (-3 dB):	50 Hz - 20 kHz [DRM212] 47 Hz - 20 kHz [DRM215] 39 Hz - 20 kHz [DRM315]
Horizontal Coverage Angle:	90° [All, DRM315 rotatable]
Vertical Coverage Angle:	60° [All, DRM315 rotatable]
Maximum SPL Peak:	134 dB [DRM212] 135 dB [DRM215] 137 dB [DRM315]
Monitor Angle	50° [DRM212 and DRM215]

### Transducers

Low Frequency:	12 in / 305 mm [DRM212] 15 in / 381 mm [DRM215 and DRM315] with ferrite
Mid Frequency:	6.5 in / 165 mm [DRM315]
High Frequency:	1.4 in / 36 mm titanium dome compression driver [All]

### Power Amplifiers

System Power Amplification	
Rated Power	1600 watts peak [DRM212] 1600 watts peak [DRM215] 2300 watts peak [DRM315]
Low Frequency Power Amplifier	
Rated Power:	1220 watts peak [DRM212] 1220 watts peak [DRM215] 1920 watts peak [DRM315]
Rated THD	< 1%
Cooling	Convection
Design:	Class D
High Frequency Power Amplifier	
Rated Power:	380 watts peak
Rated THD	< 1%
Cooling	Convection
Design:	Class D

### System Processing

Voicing	4 speaker modes
Subwoofer HPF	Off, DRM18S, Var
Main Output EQ	3-band
Delay	0 - 100 ms

### Equalization

Low	±12 dB @ 20 Hz - 200 Hz
Mid	±12 dB @ 200 Hz - 2.00 kHz
High	±12 dB @ 2.00 kHz - 20.0 kHz
HPF	40 Hz - 160 Hz (Var)

### Input/Output

Input Type:	2x Female XLR Balanced • 1/4" Balanced • 1/8" Stereo
Mic-Line Impedance:	8 kΩ balanced
1/4" TS, Wide-Z™ Impedance:	1 MΩ unbalanced
Direct Out and Mix Out:	Male XLR Balanced
Mix Out Impedance:	600 Ω balanced
Main Control:	Rotating knob

### Electronic Crossover

Crossover Type:	24 dB/octave
Crossover Frequency:	1.5 kHz [DRM212 and DRM215] 900 Hz [DRM315 LF / MF] 2.5 kHz [DRM315 MF / THF]

### Line Input Power

Detachable line cord	~100 - 240 VAC, 50 - 60 Hz, 110W ~220 - 240 VAC, 50 - 60 Hz, 110W
AC Connector	3-pin IEC 250 VAC, 10 A male
Power Supply Type	Switchmode

### Safety Features

Input Protection	Peak and RMS limiting, power supply and amplifier thermal protection
Display LEDs	Defeatable front power, Speaker Control
Status Info	Input and output levels, voicing mode, sub HPF, EQ and delay settings

### Construction Features

Basic Design:	Asymmetrical [DRM212 and DRM215] Vertical Trapezoidal [DRM315]
Enclosure Material:	Plywood
Enclosure Finish:	Black Polyurea
Grille Material:	16-18 gauge perforated steel
Grille Finish:	Powder-coated black
Handles:	One on each side [All], one on top [DRM212 and DRM215]
Display LEDs	
Front:	Power ON
Rear:	Speaker Control
Operating Temperature:	0 - 40 °C 32 - 104 °F

**Physical Properties**

**DRM212:**

Height:	25.0 in / 635 mm
Width:	14.7 in / 373 mm
Depth:	16.2 in / 411 mm
Weight:	42.0 lb / 19.1 kg

**DRM215:**

Height:	28.3 in / 719 mm
Width:	18.1 in / 460 mm
Depth:	17.0 in / 432 mm
Weight:	57.0 lb / 25.9 kg

**DRM315:**

Height:	36.5 in / 927 mm
Width:	19.0 in / 483 mm
Depth:	18.8 in / 478 mm
Weight:	68.0 lb / 30.8 kg

**Mounting Methods:**

Floor mount, pole mount via the built-in socket on the bottom of the cabinet [Be sure the pole is capable of supporting the weight of the DRM loudspeaker] or fly via the integrated M10 mounting points (using M10 x 1.5 x 20 mm forged shoulder eyebolts). See pages 19-21 for more information.

**Options**

DRM212 Cover	P/N 2036809-48
DRM215 Cover	P/N 2036809-49
DRM315 Cover	P/N 2036809-50
SPM400 Loudspeaker Pole Mount	P/N 2051055
PA-A2 Forged Shoulder Eyebolt Kit (3 x M10 x 1.5 x 20 mm)	P/N 2051054

**Disclaimer**

Since we are always striving to make our products better by incorporating new and improved materials, components, and manufacturing methods, we reserve the right to change these specifications at any time without notice.

The "Running Man" figure is a registered trademark of LOUD Audio, LLC.

All other brand names mentioned are trademarks or registered trademarks of their respective holders, and are hereby acknowledged.

©2020 LOUD Audio, LLC.  
All Rights Reserved.

**DRM212 Frequency Graph**

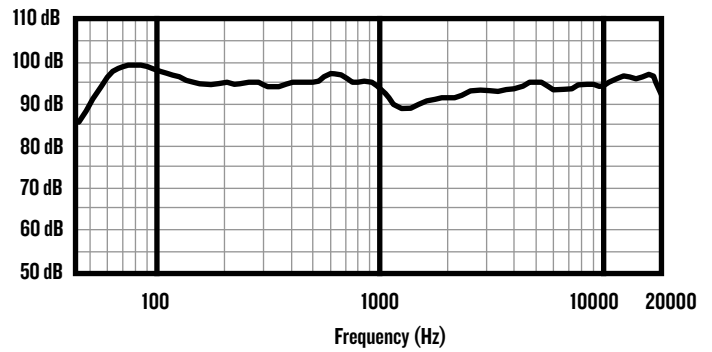

**DRM215 Frequency Graph**

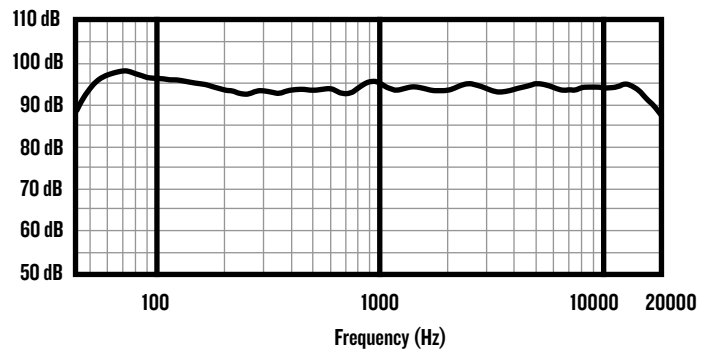

**DRM315 Frequency Graph**

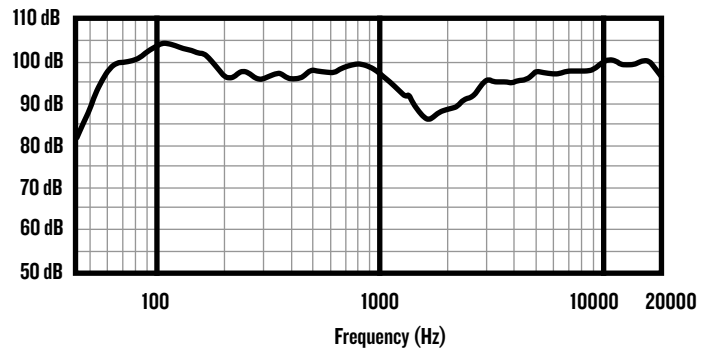

### DRM212 Loudspeaker Dimensions

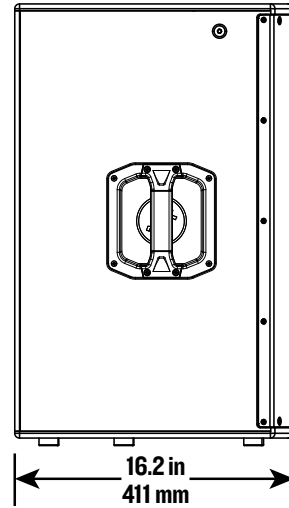
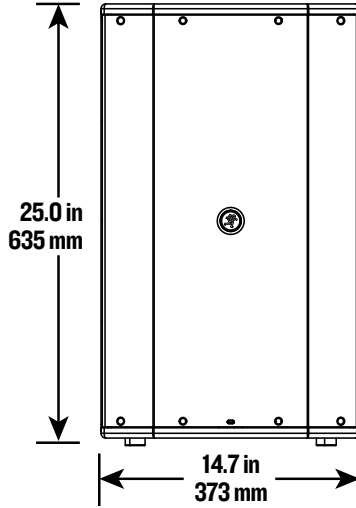

### DRM215 Loudspeaker Dimensions

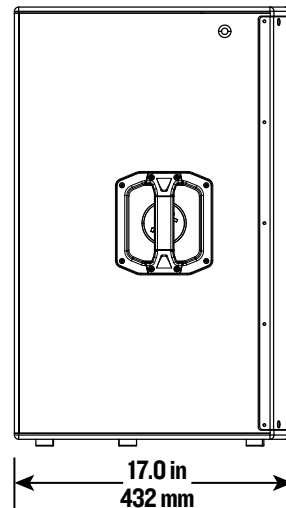
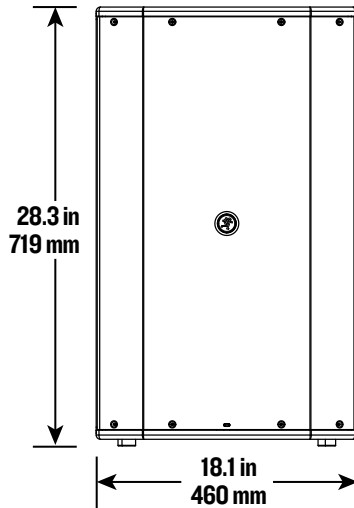

### DRM315 Loudspeaker Dimensions

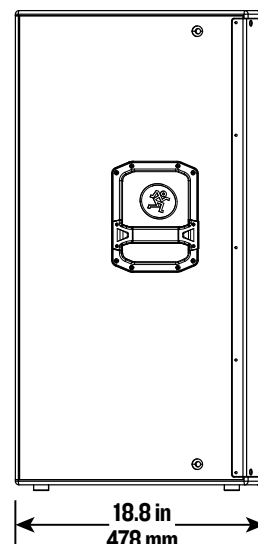
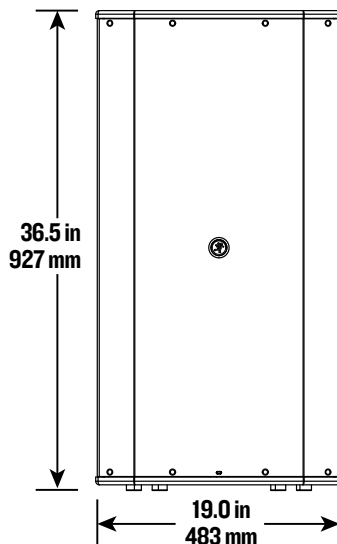
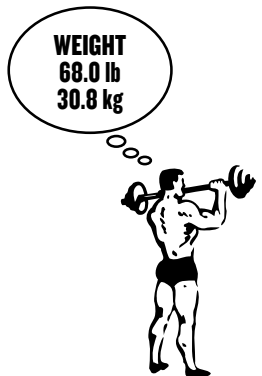

# DRM Professional Powered Loudspeaker Series

## DRM Loudspeakers Block Diagram

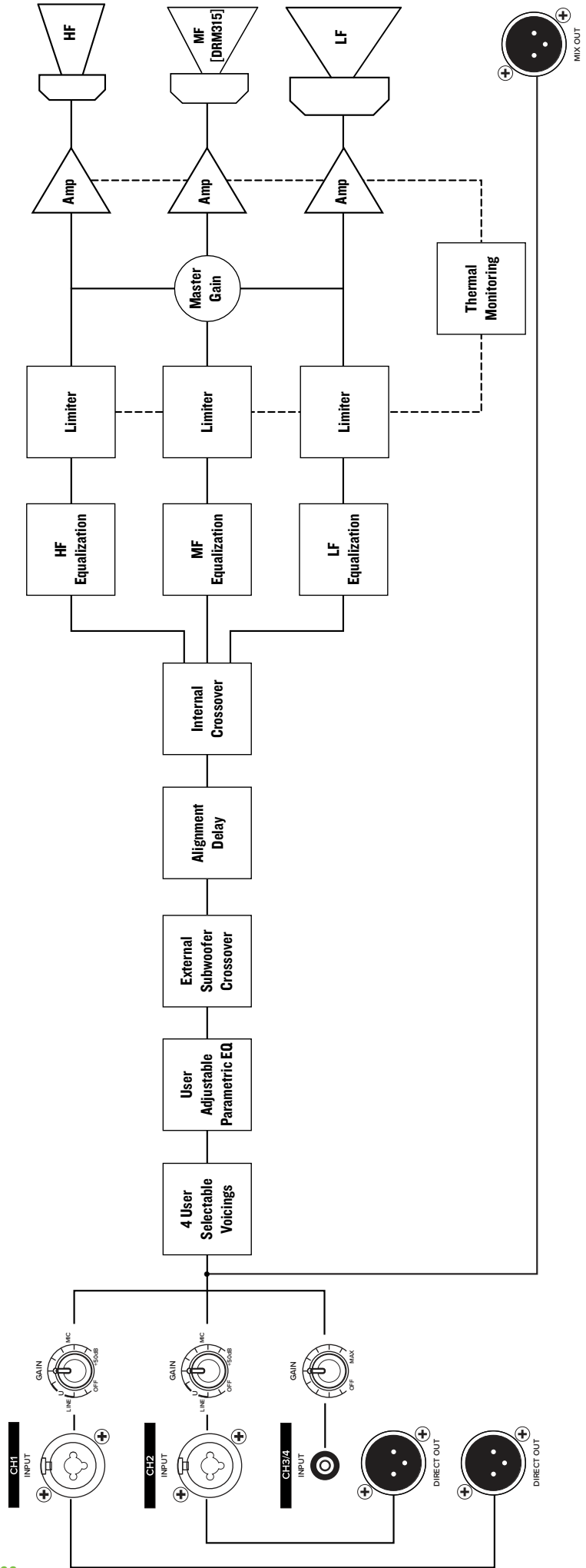



### **Please keep your sales receipt in a safe place.**

This Limited Product Warranty ("Product Warranty") is provided by LOUD Audio, LLC ("LOUD") and is applicable to products purchased in the United States or Canada through a LOUD-authorized reseller or dealer. The Product Warranty will not extend to anyone other than the original purchaser of the product (hereinafter, "Customer," "you" or "your").

For products purchased outside the U.S. or Canada, please visit [www.mackie.com](http://www.mackie.com) to find contact information for your local distributor, and information on any warranty coverage provided by the distributor in your local market.

LOUD warrants to Customer that the product will be free from defects in materials and workmanship under normal use during the Warranty Period. If the product fails to conform to the warranty then LOUD or its authorized service representative will at its option, either repair or replace any such nonconforming product, provided that Customer gives notice of the noncompliance within the Warranty Period to the Company at: [www.mackie.com](http://www.mackie.com) or by calling LOUD technical support at 1.800.898.3211 (toll-free in the U.S. and Canada) during normal business hours Pacific Time, excluding weekends or LOUD holidays. Please retain the original dated sales receipt as evidence of the date of purchase. You will need it to obtain any warranty service.

For full terms and conditions, as well as the specific duration of the Warranty for this product, please visit [www.mackie.com](http://www.mackie.com).

The Product Warranty, together with your invoice or receipt, and the terms and conditions located at [www.mackie.com](http://www.mackie.com) constitutes the entire agreement, and supersedes any and all prior agreements between LOUD and Customer related to the subject matter hereof. No amendment, modification or waiver of any of the provisions of this Product Warranty will be valid unless set forth in a written instrument signed by the party to be bound thereby.

### **Need help with the DRM loudspeakers?**

- Visit [www.mackie.com/support](http://www.mackie.com/support) to find: FAQs, manuals, addendums, and other documents.
- Email us at: [www.mackie.com/support-contact](http://www.mackie.com/support-contact)
- Telephone 1-800-898-3211 to speak with one of our splendid technical support chaps (Monday through Friday, normal business hours, Pacific Time).



---

**19820 North Creek Parkway #201**

**Bothell, WA 98011 • USA**

**Phone: 425.487.4333**

**Toll-free: 800.898.3211**

**Fax: 425.487.4337**

**[www.mackie.com](http://www.mackie.com)**

---